

ME A-UWB-LTE-90

OMNI-DIRECTIONAL ANTENNA

Part #: 100-00139-01



Description

ME A-UWB-LTE-90 is an ultra wideband antenna that provides broad coverage 690MHz- 960MHz / 1710MHz-2700Mhz and is compatible with most 4G LTE, 3G and 2G standards. This is a high efficiency high gain omnidirectional antenna ideally suited for gateways, routers , access points, repeaters and other WLAN applications. The antenna is 7 mm long, featuring a tilt-and-swivel SMA plug connector for a vertical, and any angle use. The antenna features a 360° horizontal transmission pattern and a 50° vertical transmission pattern.

Electrical Specifications

Parameter	Specification
Frequency Range	690-960/1710-2700 MHz
VSWR	1:2.2
Impedance	50 Ω
Polarization	RHCP
Gain	2.5 / 3.5 dBi
Polarization	Vertical
Radiation	Omni
Max Power	50 W

Mechanical Specifications

Parameter	Specification
Height	163 mm
Wither	22 mm
Height	7 mm
Connector	SMA male
Lighting Protection	Grounding

Features

- LTE / GSM / CDMA /DCS /PCS / WCDMA / UMTS / HSDPA / GPRS / EDGE /GPS /Wi-Fi 690MHz to 960MHz 1710MHz to 2700Mhz
- Ultra Wide Band Antenna
- Ground Plane Independent
- Hinged 90° termination with SMA(M) Connector

Applications

- Infotainment systems - HD video transmission - Dash cameras
- Connected cars
- Fleet management
- Gateways
- Routers
- Public transportation
- Logistics

Radiation Performance

MEA-UWB-LTE-90

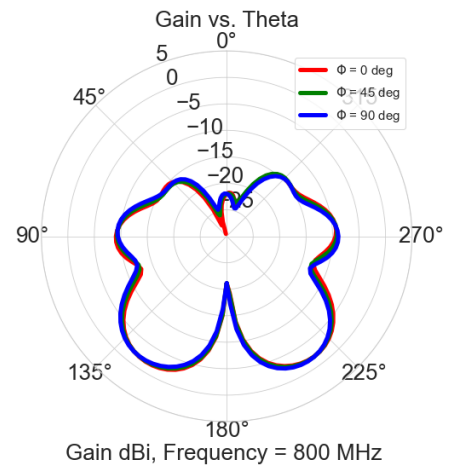
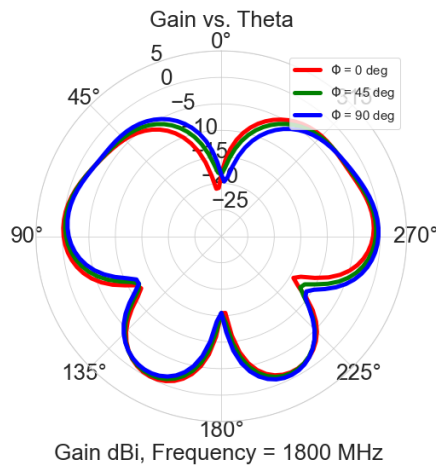
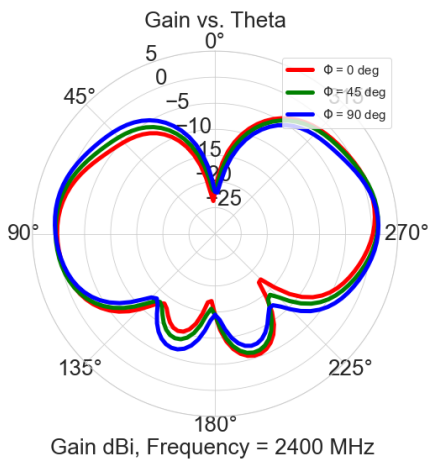
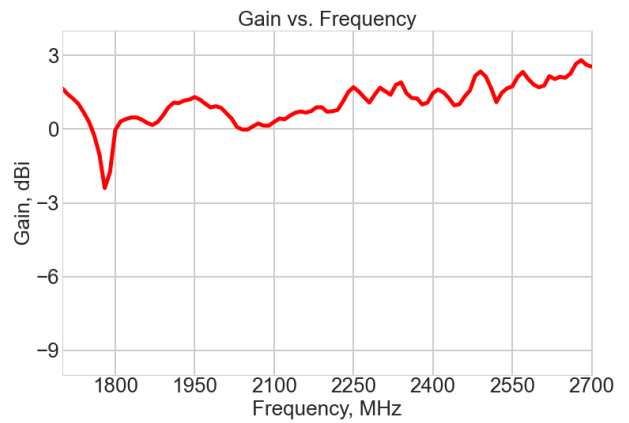
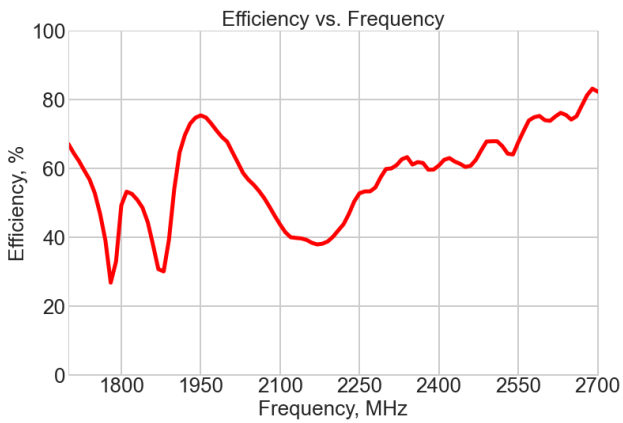
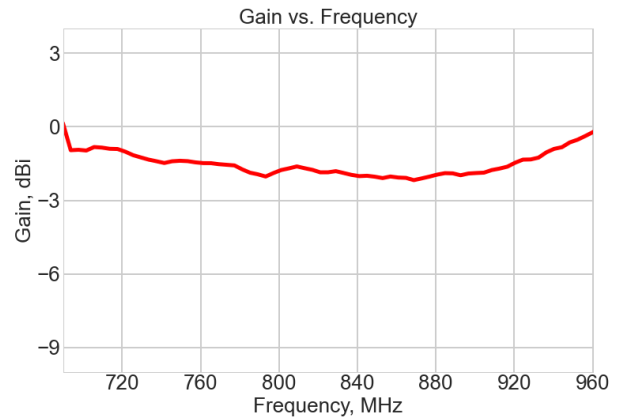
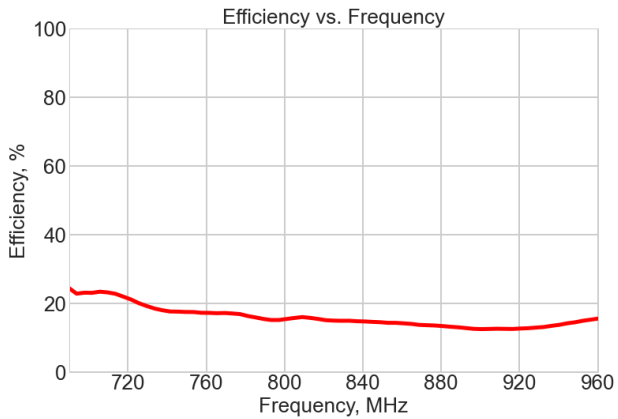

Radiation Performance

MEA-UWB-LTE-90

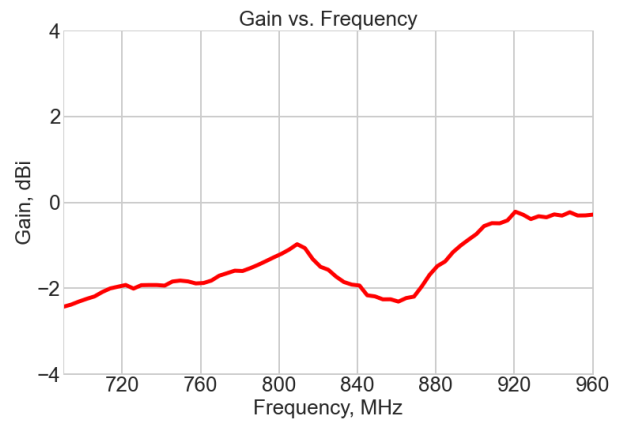
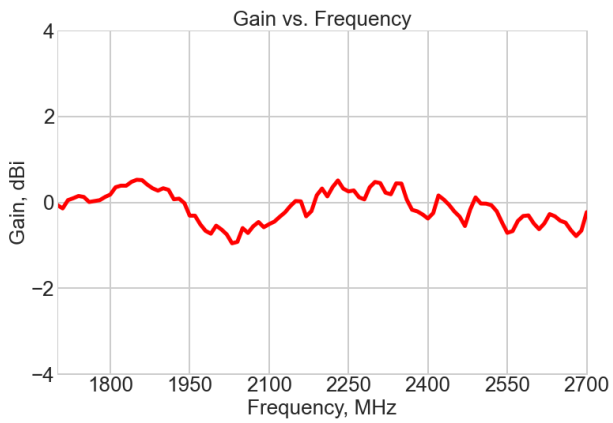
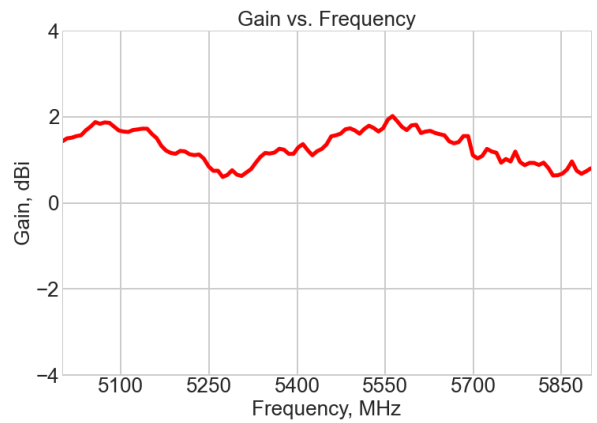
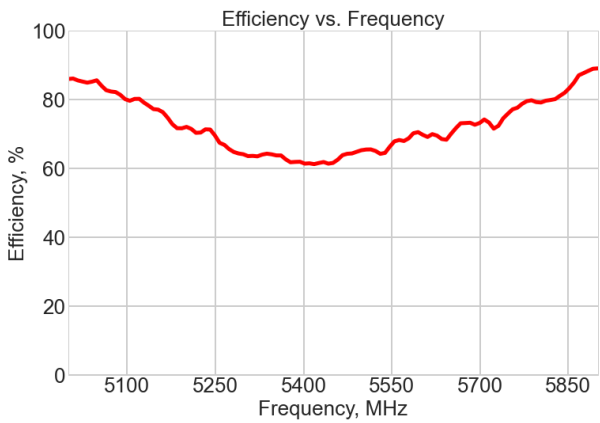
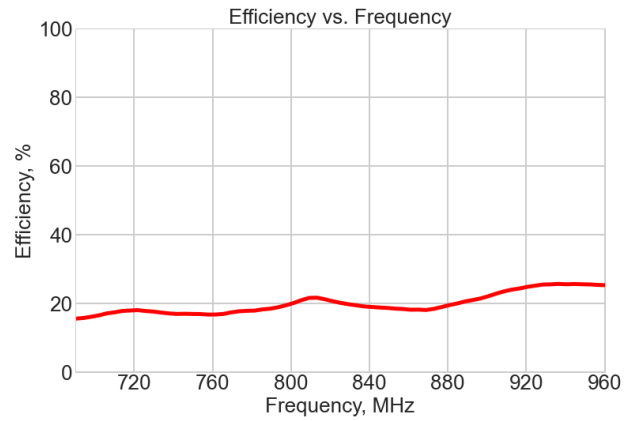
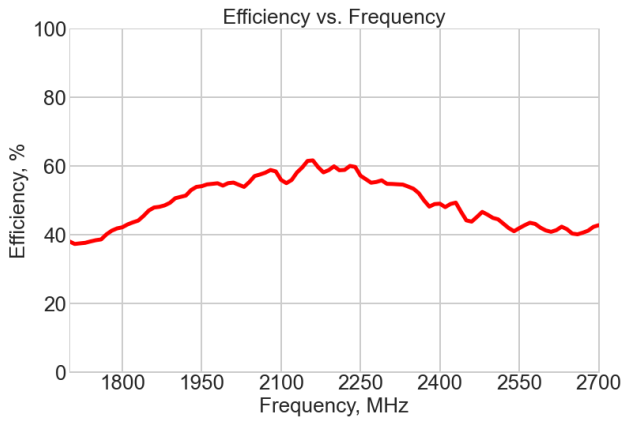

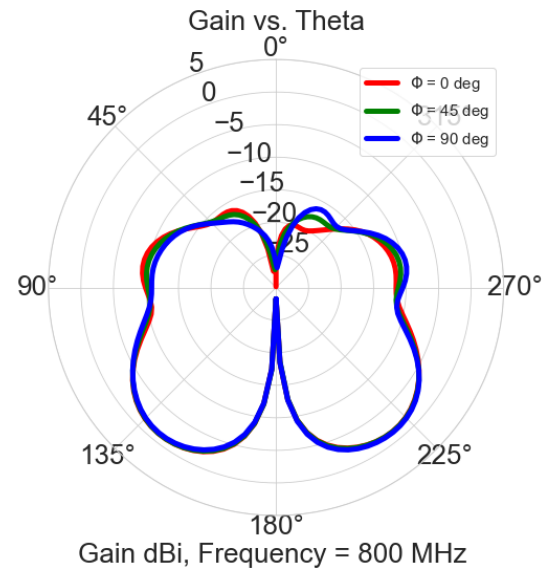
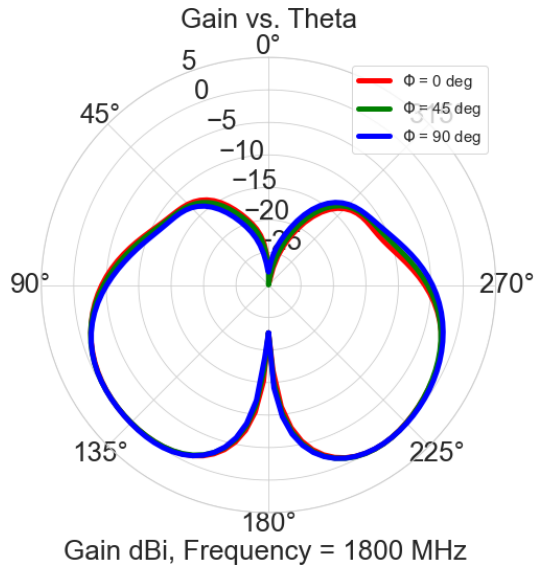
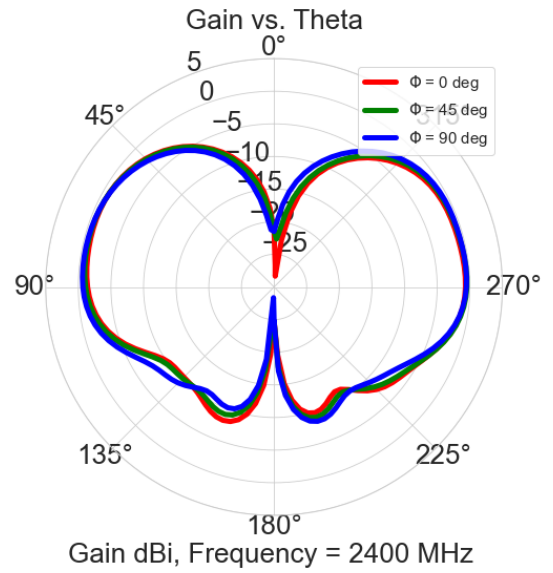
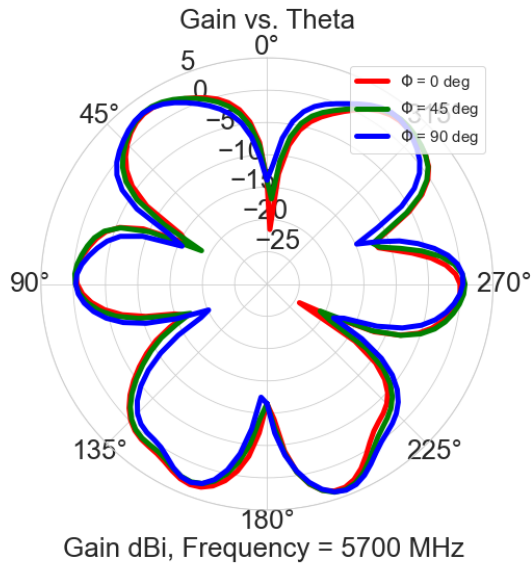

DRAWING REVISION HISTORY			
REV	DESCRIPTION	DATE	BY
A	INITIAL RELEASE	9/23/2020	QZ

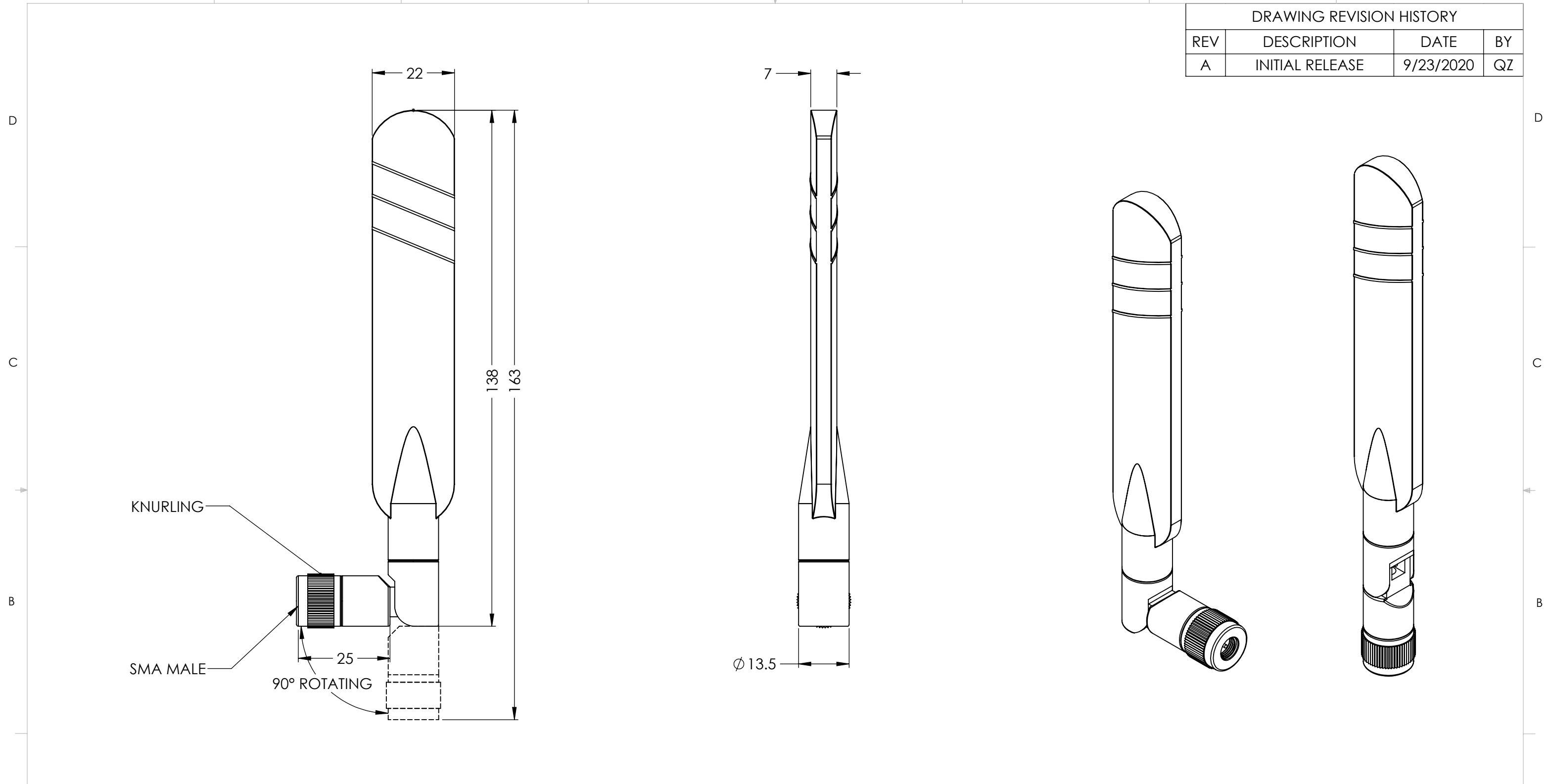

NOTES:
BASE COULD ROTATE FROM 0 DEGREE TO 90 DEGREES.

ITEM 100-00139-01 REVISION HISTORY			
REV	DESCRIPTION	DATE	BY
A	INITIAL RELEASE	2020-9-23	QZ

PROPRIETARY AND CONFIDENTIAL

THE INFORMATION CONTAINED IN THIS DRAWING IS THE SOLE PROPERTY OF MAXTENA, INC. ANY REPRODUCTION IN PART OR AS A WHOLE WITHOUT THE WRITTEN PERMISSION OF MAXTENA, INC IS PROHIBITED.

UNLESS OTHERWISE SPECIFIED:	NAME	DATE
DIMENSIONS ARE IN MM	DRAWN	QZ 2020-09-23
TOLERANCES:	CHECKED	ZX 2020-09-24
FRACTIONAL ±	ENG APPR.	NPC 2020-09-30
ANGULAR: MACH ± .5° BEND ±	MFG APPR.	
INTEGER ±2	Q.A.	
ONE PLACE DECIMAL ±1.0		
INTERPRET GEOMETRIC TOLERANCING PER:	CAD MAINTAINED. CHANGES SHALL BE INCORPORATED BY THE DESIGN ACTIVITY.	
	DO NOT SCALE DRAWING	

MAXTENA, INC		
TITLE: 100-00139-01 MEA-UWB-LTE-90		
SIZE	DWG. NO.	REV
B	117-00352-01	A
CAGE CODE: 5KQH7	SCALE: NONE	SHEET 1 OF 1