



MEA-4950-ISM-AM

2.4/5.0/6.0 GHz ISM MIMO Adhesive Mount

Part #: 100-00331-01

Description

The MEA-4950-ISM-AM is a 3-in-1 antenna that combines high performance 5G, MIMO, and ISM standard. The antenna's excellent radiation pattern, exceptional out-of-band rejection, and low noise figure ensures optimal performance. It features a 3m cable with an integrated SMA Male, SMB, or MCX connector (customer choice). This low-profile adhesive mount is ideal for public safety, utilities tracking, and IOT applications. This antenna offers an ultra-low-profile design with easy mounting and customizable cables and connector options. The antenna is designed with rugged ASA black housing and is ideal for the most demanding environmental challenges. The MEA-4950-ISM-AM is IP67 rated.

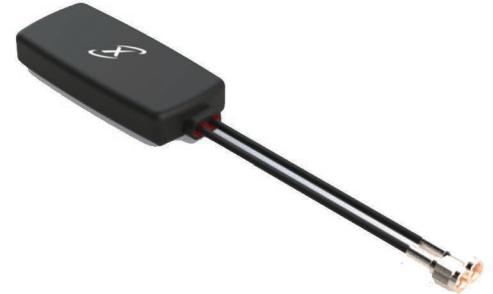

Electrical Specifications

Cable 1	Parameter	Specifications		
	Standards	WiFi, BT, ZigBee, ISM		
Band	2.4 GHz	5.0 GHz	6.0 GHz	
Efficiency (%)	~50.1	~46.8	~45.1	
Frequency(MHz)	2410-2490	4920-5925	5925-7125	
Return Loss	~-21.9	~-16.0	~-13.5	
VSWR	~1.2:1	~1.5:1	~1.6:1	
Peak Gain (dBi)	~-5.5	~-6.2	~-4.7	
Average Gain (dB)	~-3.0	~-3.8	~-4.1	
Impedance (Ohm)	50			
Polarization	Linear			
Radiation Pattern	Omni-Directional			
Max Input Power	25			
Connector Type	Most RF Connectors (SMA-Male Standard)			
Cable Length	Any Cable Length (300cm Standard)			
Cable Type	Other Cables Available (LL100 Standard)			

Cable 2	Parameter	Specifications		
	Standards	WiFi, BT, ZigBee, ISM		
Band (MHz)	2.4 GHz	5.0 GHz	6.0 GHz	
Frequency(MHz)	2410-2490	4920-5925	5925-7125	
Return Loss	~-18.4	~-13.2	~-10.9	
VSWR	~1.3:1	~1.7:1	~2.0:1	
Peak Gain (dBi)	~-4.0	~-6.1	~-5.1	
Average Gain (dB)	~-3.1	~-4.0	~-4.5	
Impedance (Ohm)	50			
Polarization	Linear			
Radiation Pattern	Omni-Directional			
Connector Type	Most RF Connectors (SMA-Male Standard)			
Cable Length	Any Cable Length (300cm Standard)			
Cable Type	Other Cables Available (LL100 Standard)			

Features

- Cable 1-2: 2.4/5.0/6.0 GHz ISM – 2410-2490 MHz - 4920-7125 MHz
- Adhesive mount
- Wifi 6E Antenna
- Ground Plane Independent
- IP67, IP69
- 83 x 35 x 13.3 mm
- Compact Size
- Customizable Cable and Connector

Applications

- IoT applications
- Transportation
- Tracking/ Mapping devices
- Asset Tracking
- Telematics
- Container & Logistics
- Automotive
- Industrial Applications



Maxtena Inc.
20310 Seneca Meadows Pkwy Suite A
Germantown, MD 20876
1-877-629-8362
info@maxtena.com

www.maxtena.com

Mechanical Specifications

Parameter	Specifications
Antenna Dimensions (mm)	83 x 35 x 13.3
Operating Temperature (C)	-40 to +85
Storage Temperature (C)	-40 to +85
Mounting Type	Adhesive Mount
Radome Type/Color	ABS UV Stable/ Black
Substance Compliance	RoHS
Ingress Protection	IP67, IP69

Antenna Parameters

Cable 1

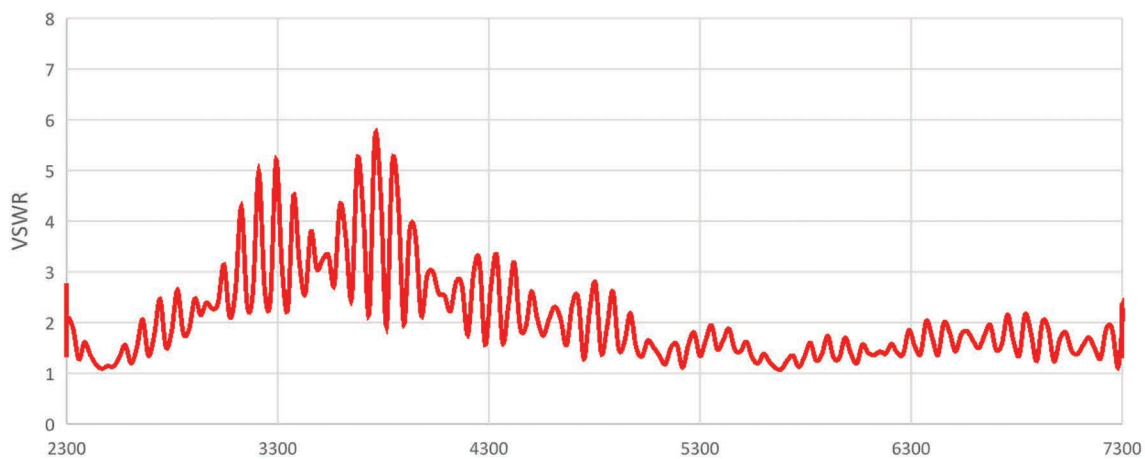
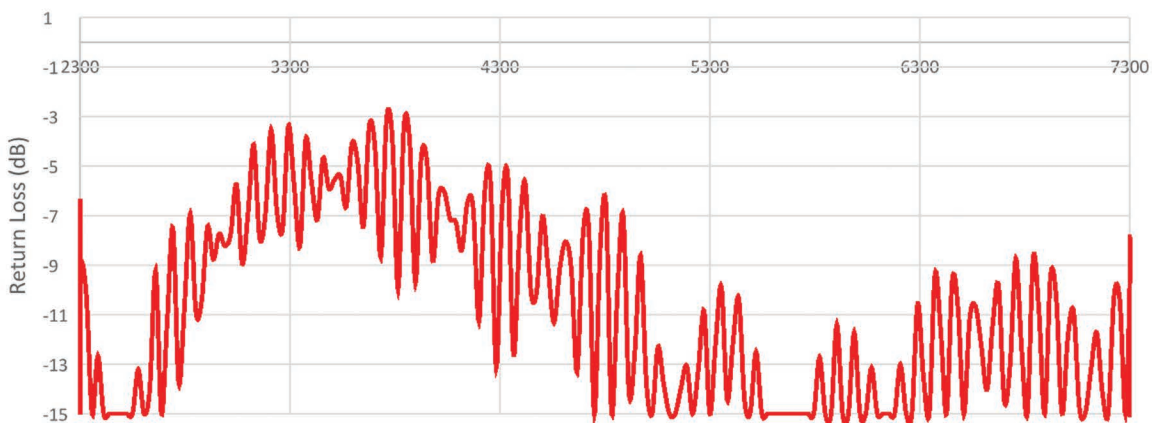

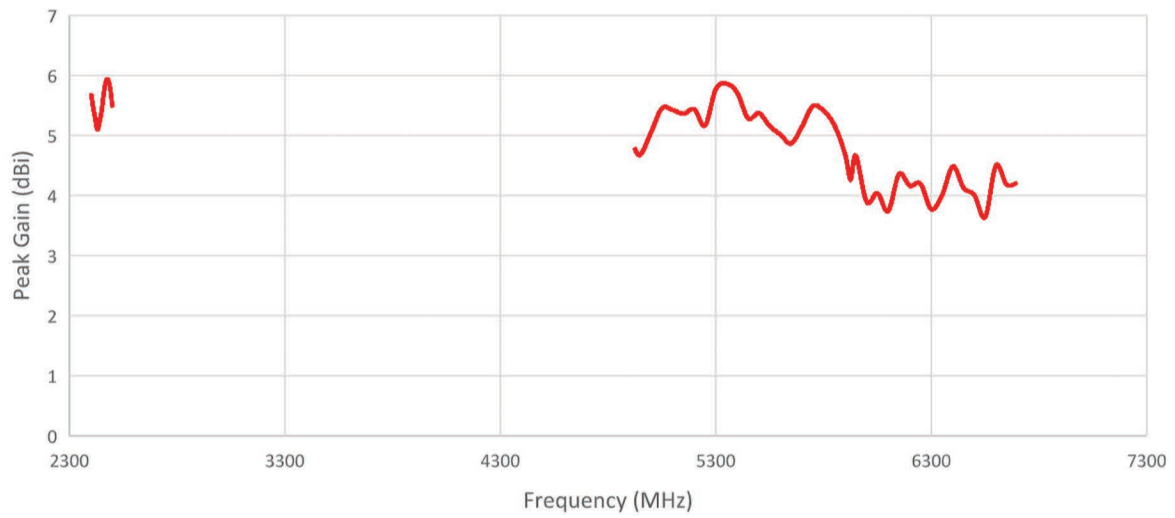
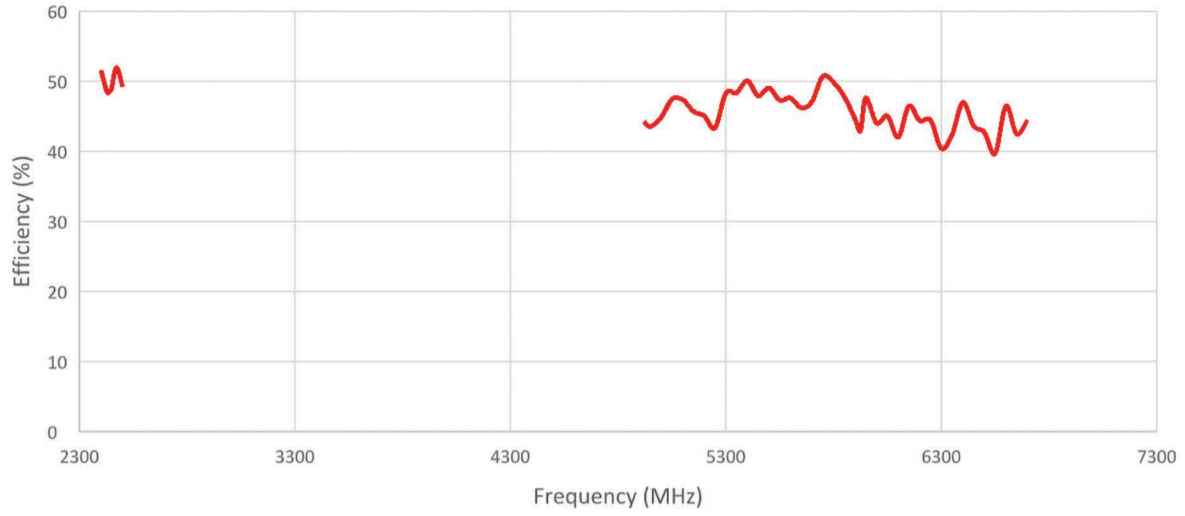

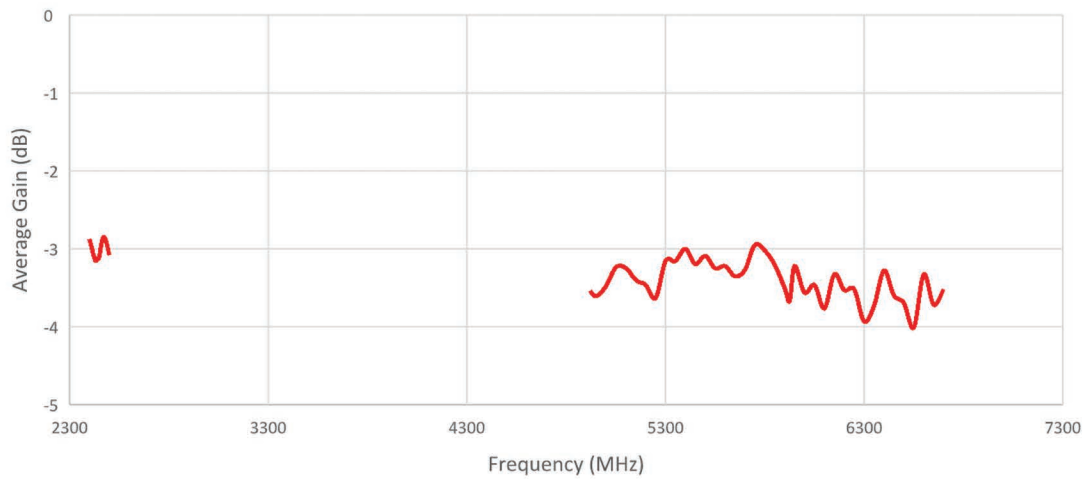

Cable 2

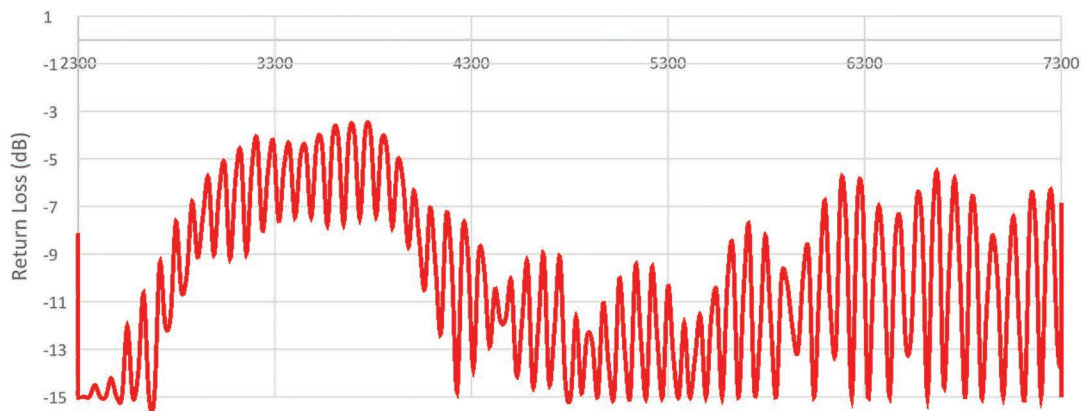

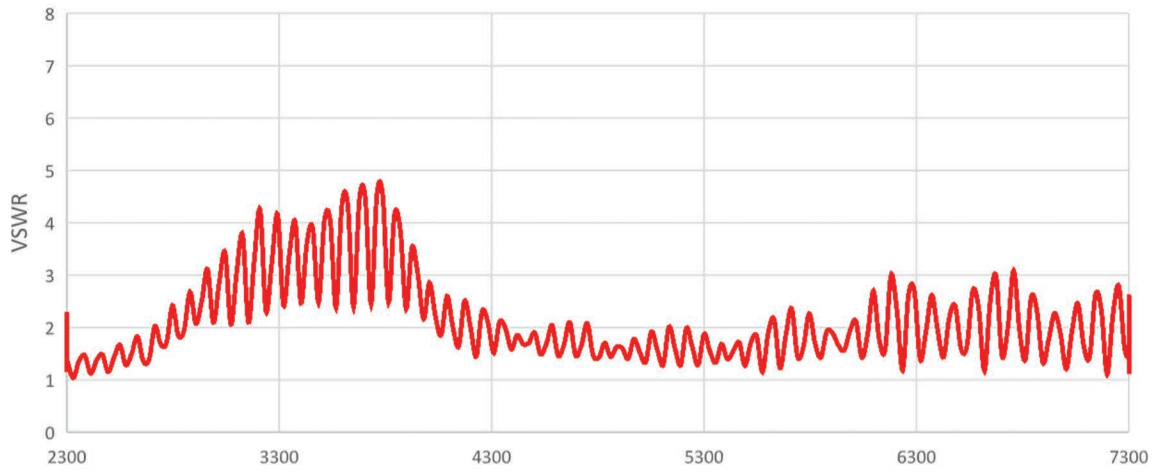

Cable 2

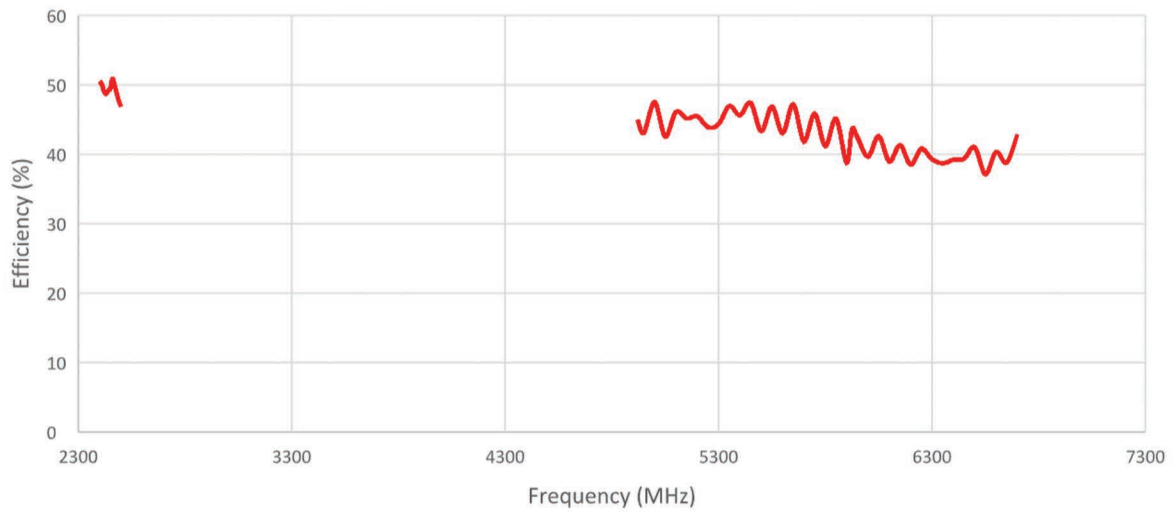

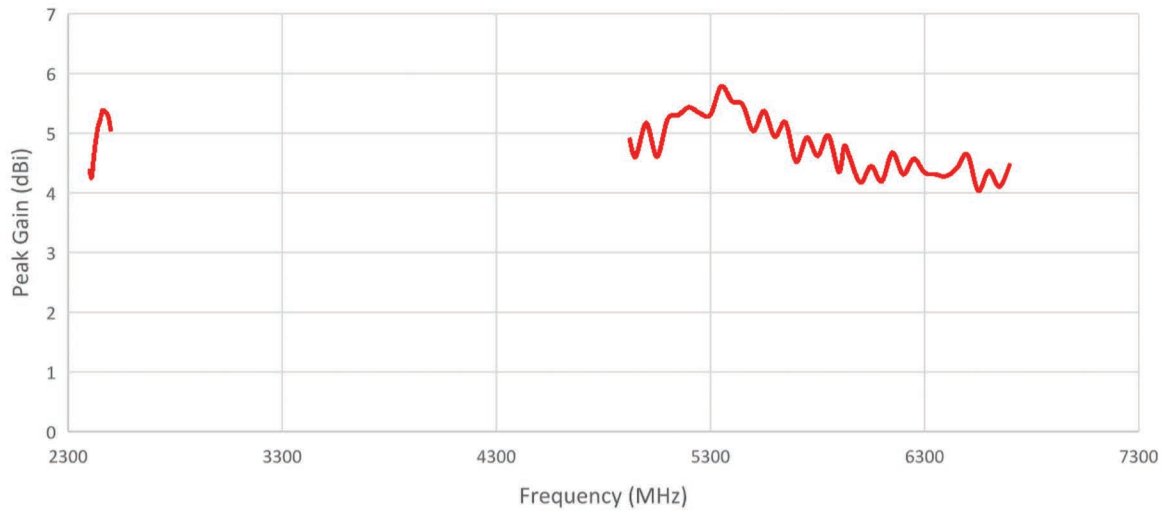

Cable 2

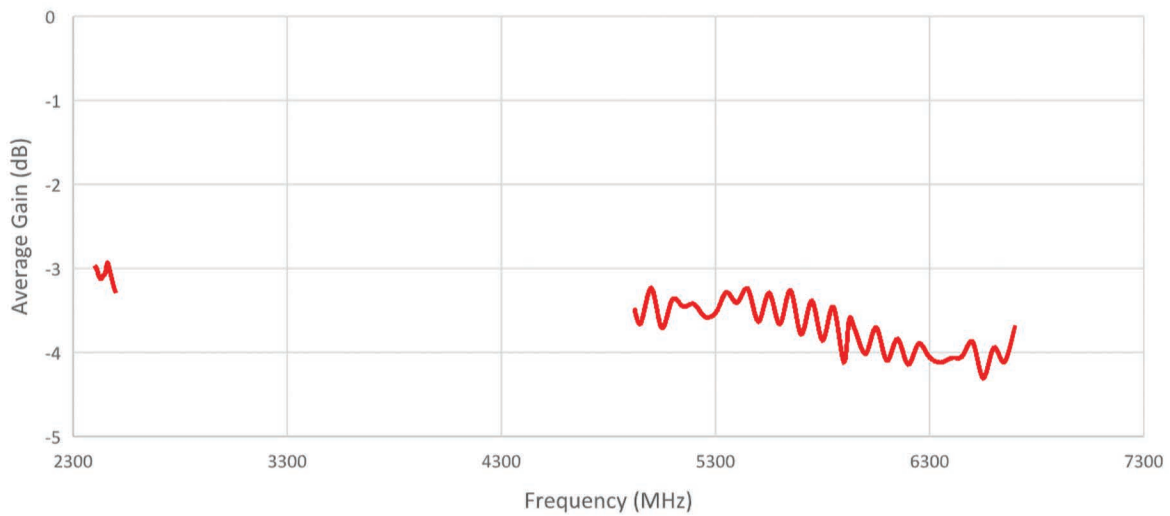

ISOLATION FOR CABLES 1 AND 2

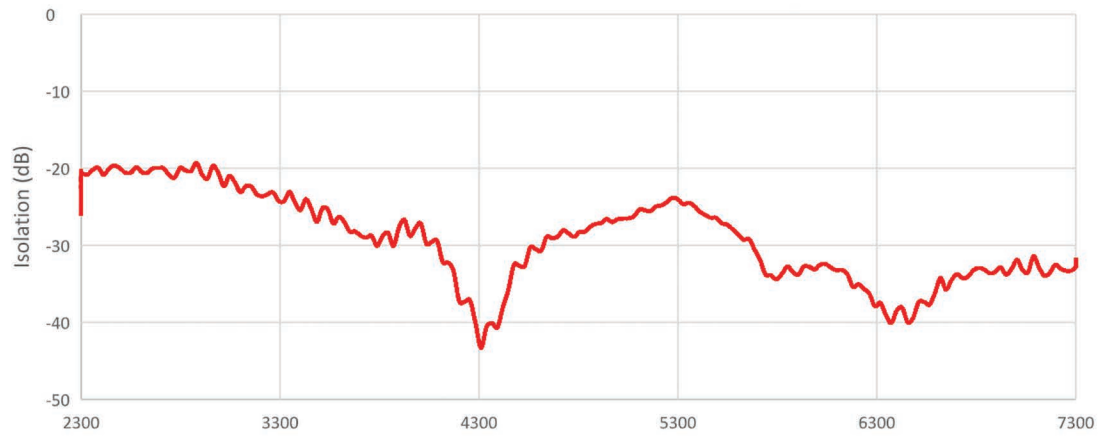

ENVELOPE CORRELATION COEFFICIENT FOR CABLES 1 AND 2

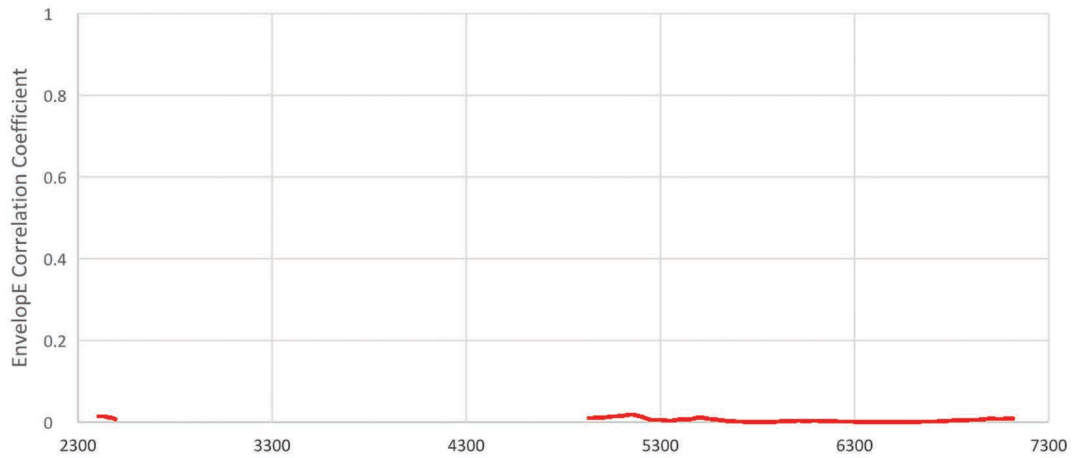

DRAWING REVISION HISTORY			
REV	DESCRIPTION	DATE	BY
A	INITIAL RELEASE	2023-11-23	MP

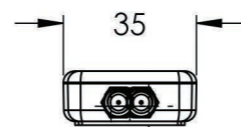
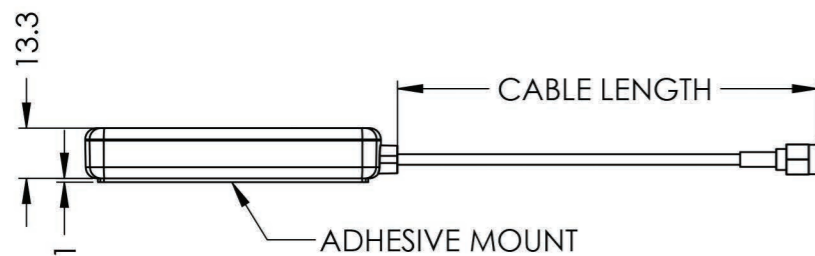
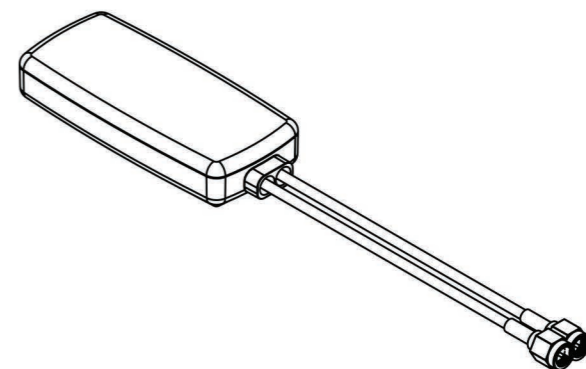
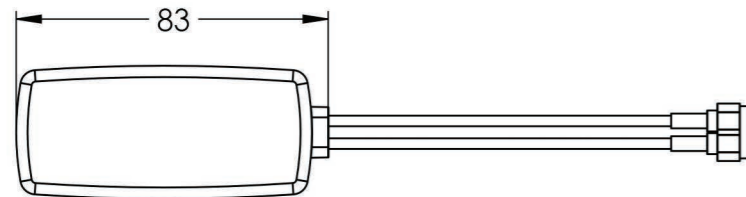

NOTES:

- FREQUENCY:
 - CABLE 1-2: 2.4/5.0/6.0 GHz ISM
- CUSTOMIZABLE CABLE AND CONNECTOR OPTIONS
- MOUNTING TYPE: ADHESIVE MOUNT
- DIMENSIONS ARE AFTER MOUNTING
- MATERIALS:
 - RADOME: ABS UV STABLE
 - RADOME COLOR: BLACK
- OPERATING TEMPERATURE: -40°C ~ +85°C
- STORAGE TEMPERATURE: -40°C ~ +85°C
- CERTIFICATIONS: IP67, IP69

UNLESS OTHERWISE SPECIFIED:	NAME	DATE
DIMENSIONS ARE IN MM	DRAWN MP	2023-11-23
TOLERANCES:	CHECKED BO	2023-11-27
FRACTIONAL ±	ENG APPR. AV	2023-11-27
ANGULAR: MACH ± .5° BEND ±	MFG APPR.	
ONE PLACE DECIMAL ± 1.0	Q.A.	
TWO PLACE DECIMAL ± .50		
INTERPRET GEOMETRIC TOLERANCING PER:	CAD MAINTAINED. CHANGES SHALL BE INCORPORATED BY THE DESIGN ACTIVITY.	
	DO NOT SCALE DRAWING	

MAXTENA, INC		
TITLE: 100-00331-01 MEA-4950-ISM-AM		
SIZE B	DWG. NO. 117-00756-01	REV A
CAGE CODE: 5KQH7	SCALE: NONE	SHEET 1 OF 1

100-00331-01 CONFIGURATION TABLE				
DASH NO	CABLE TYPE	CABLE LENGTH	CONNECTOR TYPE	RADOME COLOR
-01	CABLE 1: LL100	300CM	SMA MALE	BLACK

ITEM 100-00331-01 REVISION HISTORY			
REV	DESCRIPTION	DATE	BY
A	INITIAL RELEASE	2023-11-23	MP

PROPRIETARY AND CONFIDENTIAL
THE INFORMATION CONTAINED IN THIS DRAWING IS THE SOLE PROPERTY OF MAXTENA, INC. ANY REPRODUCTION IN PART OR AS A WHOLE WITHOUT THE WRITTEN PERMISSION OF MAXTENA, INC IS PROHIBITED.